

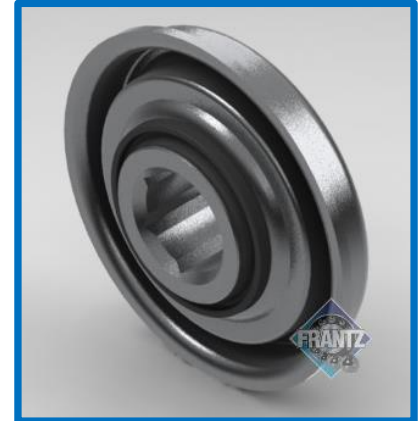

1971

GenII® Semi-Precision Bearing



Specifications

- Bearing Type:** Semi Precision, Adapter Style
- Load Capacity:** 620 lbs.
- Mounting Type:** Press & Swage Fit *
- Tube Size/Gauge:** 2.5" x 11g
- Max OD of Body:** 2.267"
- Bore Size & Type:** 5/8" – Hex
- Extension:** .305"
- Lubrication:** Oil or Grease
- Noise Level:** Quiet
- Temperature Range:** Oil, -10 to 248 F°
Grease, -10 to 248 F°
- Protection:** Front Polymer Seal
- Regreasable:** No – Maintenance Free

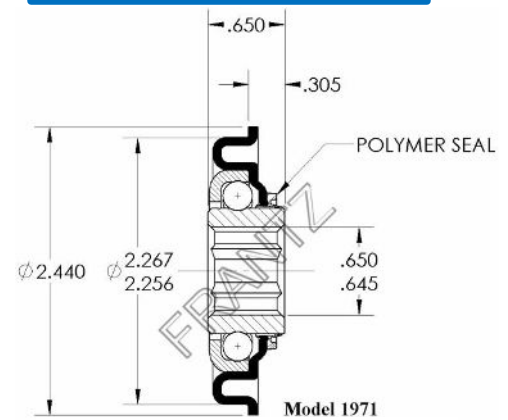

Part Number for Ordering:
Oil - 1971226023
Grs - 1971226123

Applications: Benefits & Features

Precision Bearing Alternative: GenII® equals low noise, high speed and long life. Components manufactured utilize tight tolerances, which helps provide for longer product life compared to standard conveyor bearings and a lower cost alternative to precision bearings. The FRANTZ Iron Grip carbon steel adapter allows for secure swage fitment.

Targeted Applications: Gravity and powered conveyors used primarily in manufacturing, packaging, shipping, warehousing and assembly. Performs well in refrigerated/freezer applications. Commonly used in corrugation industry.

Low Noise / High Speed Applications: Proprietary raceway manufacturing and precision Sterling® Steel Balls allows for lower operating noise levels and speeds up to 360 SFM.

Long Life: FRANTZ GenII® has been rigorously tested and provides up to 10X the life of standard commercial conveyor bearings.

* Also Slip & Swag fit into 2-1/2" 12g tube and Press & Swage fit into 2-5/8" 7g tube. Contact FRANTZ Customer Service if you have questions regarding mounting applications.

...Roll Easy with FRANTZ®

FRANTZ

Customer Service, Product Samples and Quotations: 815.625.7063

FRANTZ Manufacturing Company P.O. Box 497, Sterling IL 61081-0497 www.frantz-mfg.com